

Internal Dimensions		
Width	Depth	Height
806	436	420
Weight	Approx. 27 Kg	
Wall Thickness		10mm

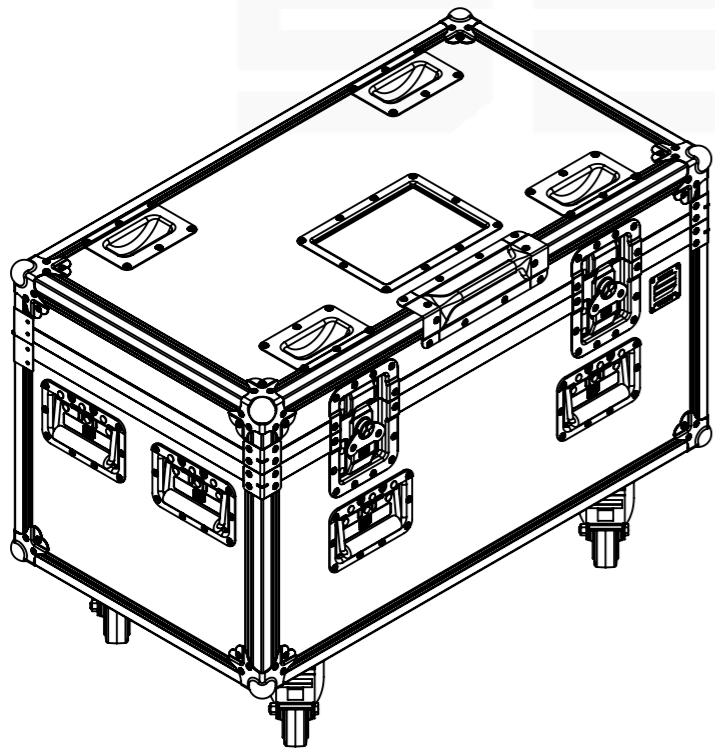

SECTION A-A

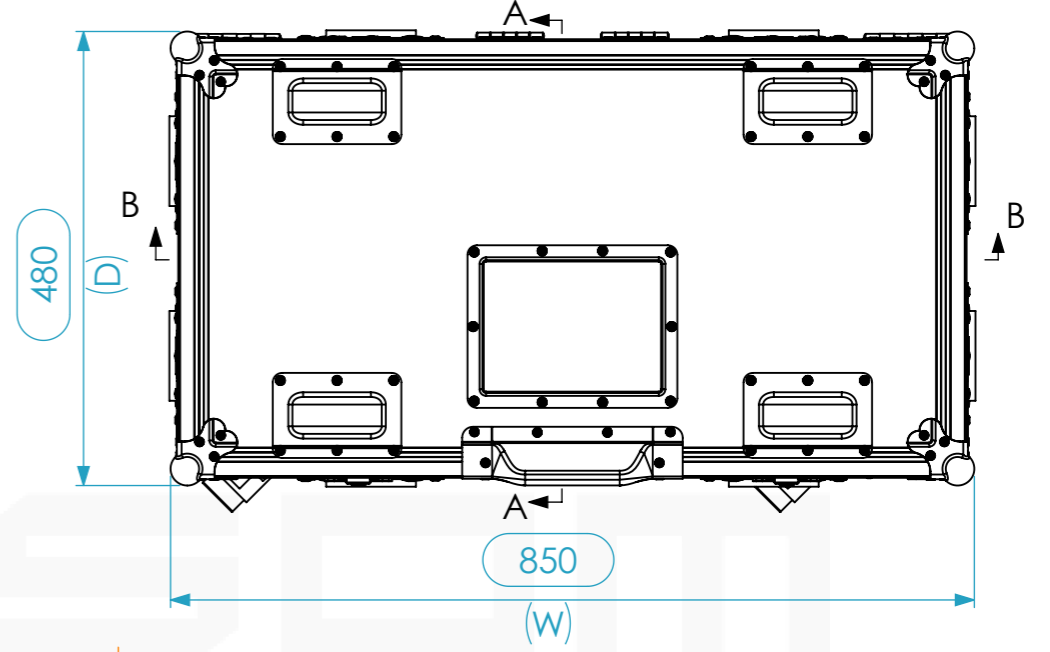
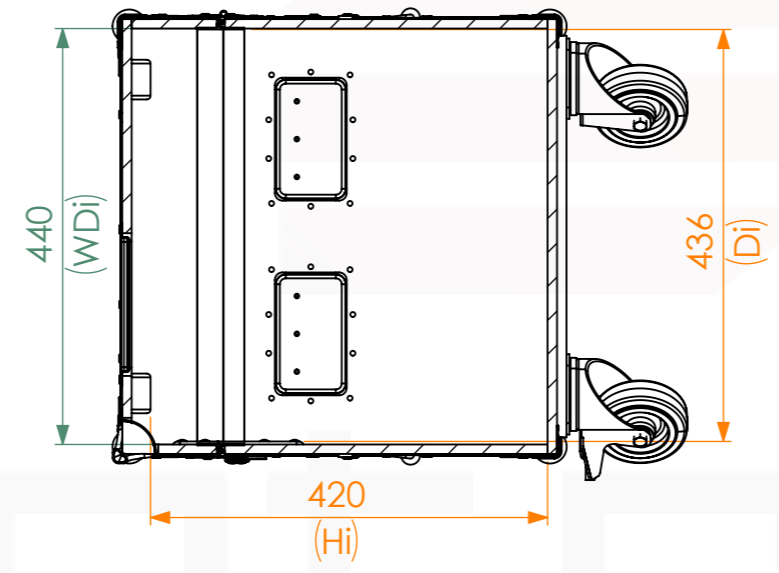
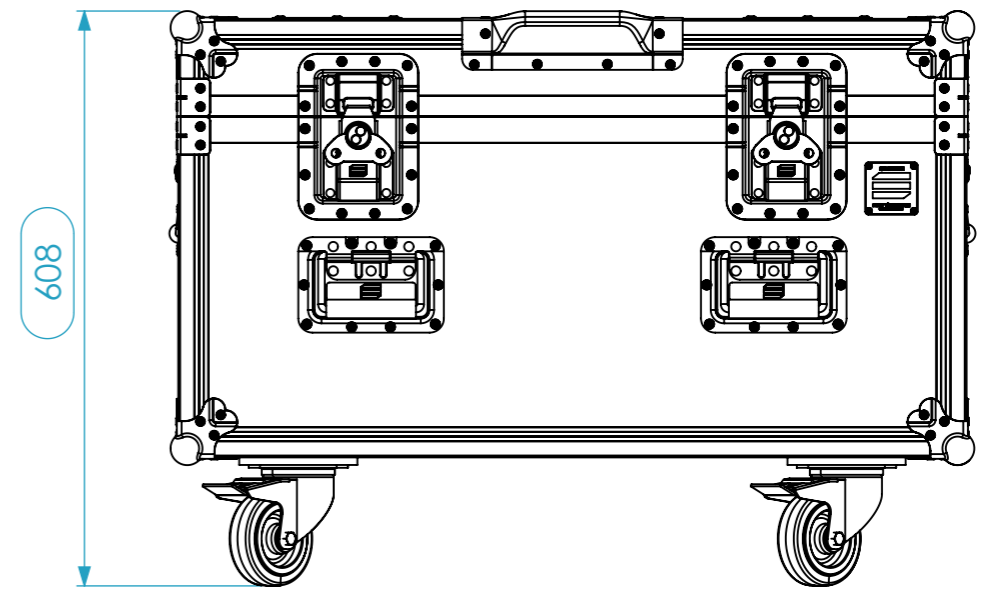
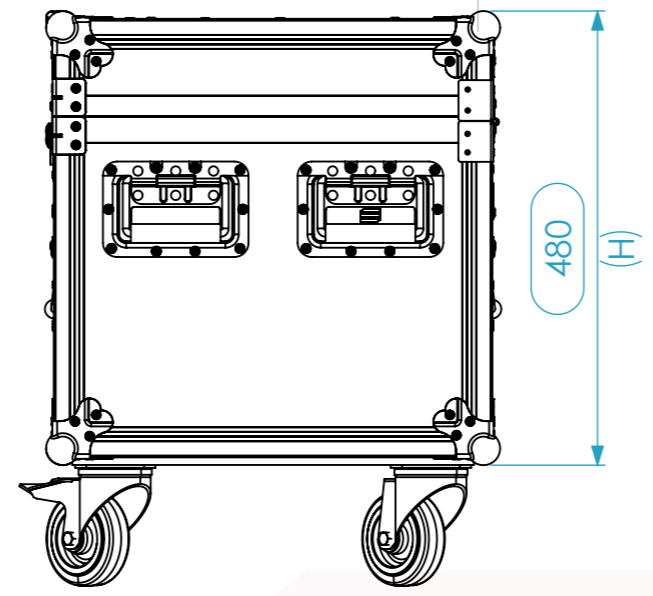
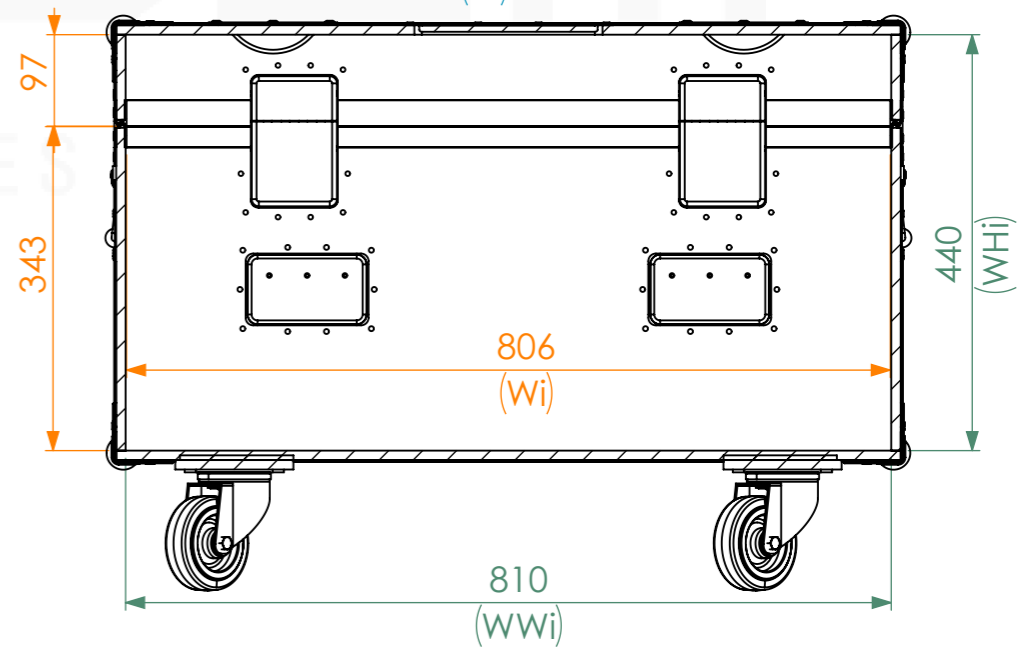

SECTION B-B

General External Dimensions		Usable Inner Dimensions (UID)		Wood Inner Dimensions (WID)	
W	Width	Wi	Inside Width	WWi	Wood Inside Width
D	Depth	Di	Inside Depth	WDi	Wood Inside Depth
H	Height	Hi	Inside Height	WHi	Wood Inside Height

Name	Date
Drawn by	CatarinaHenriques 23/07/2018
Reference	X1AAR.0854848
Scale	1:8
units in mm	general tolerance 0.8mm
DO NOT SCALE	FC. X1AA. 806X436X440



This drawing must not be copied or disclosed without consent of the owner



A3