

**CST.AW08.MIC2**  
 PW True1, 2x Mic, 2x RJ45, 2 BNC  
 UV printed features included:  
 Pwr (in/out), mic channels (1->2), Eth/Dante  
 COM Ports (1/2), BNC COM Ports (A/B)

**19"x14" 2U Aluminium  
 Rack Drawer**  
 10 kg load-bearing capacity  
 (\*)

**Equipment protection and  
 packaging foam unit.**  
 (UV printed info included)

**RCS.0560  
 Rack Compact Sliding, 5U**

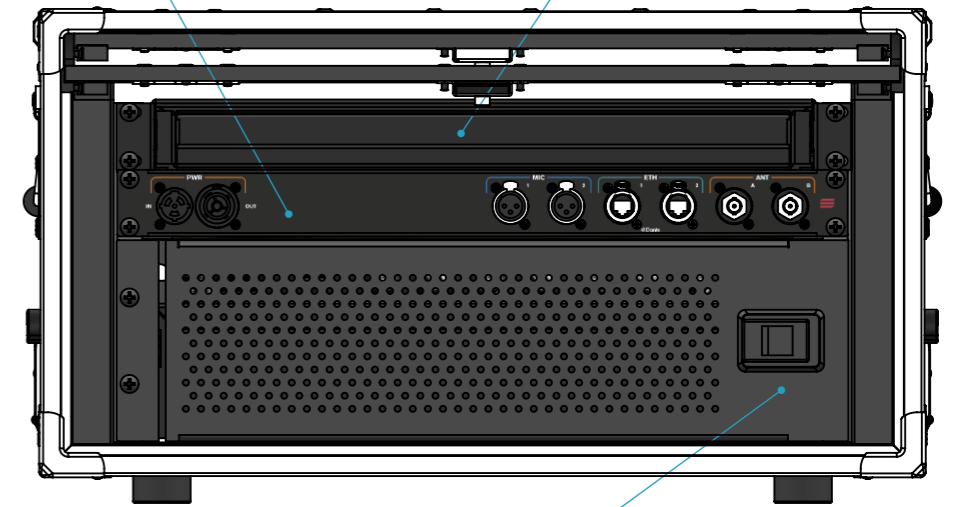

**19" 3U Hinged Rack Panel,  
 Vented.**  
**Black Powder Coated.**

Your  
**LOGO**  
 here

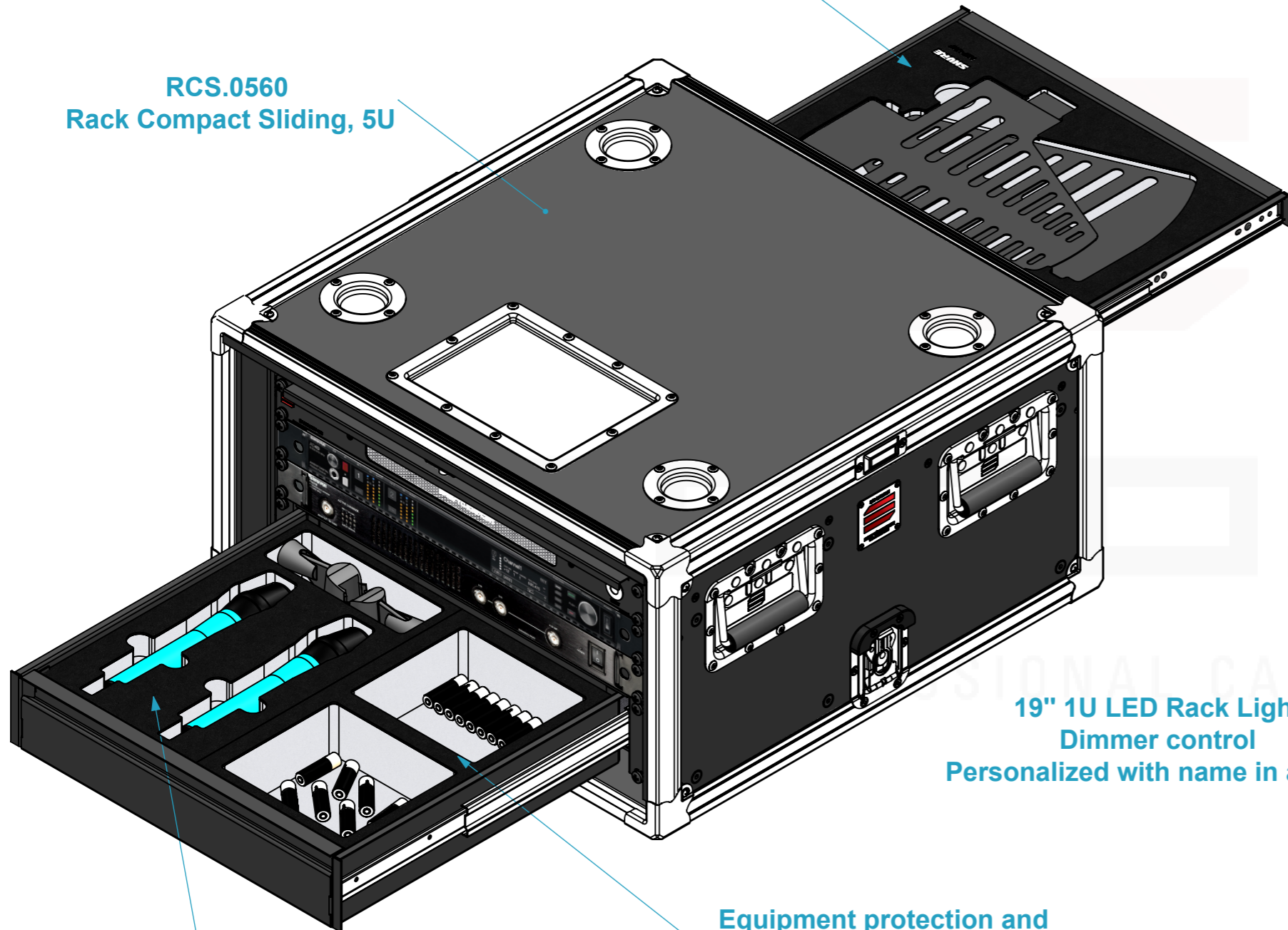

**19" 1U LED Rack Light**  
 Dimmer control  
 Personalized with name in acrylic

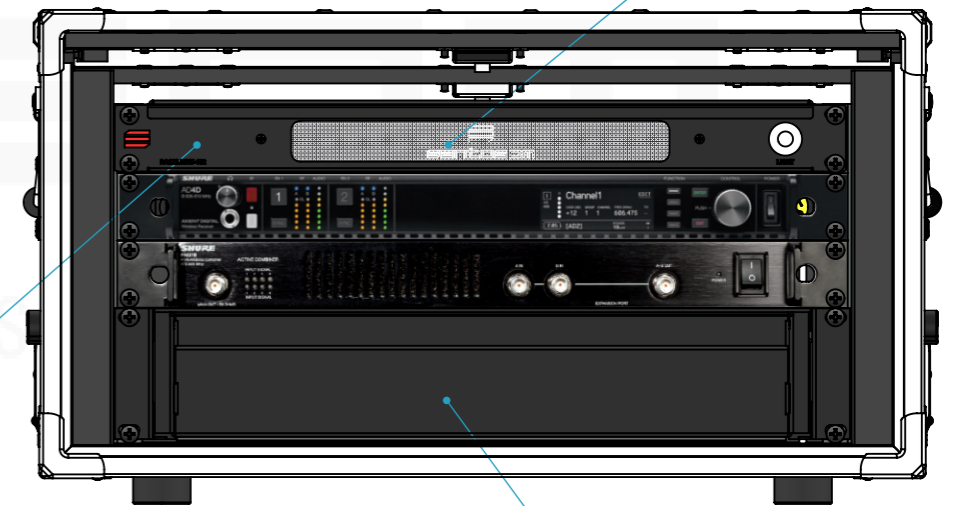

**19"x 14" 2U Aluminium  
 Rack Drawer**  
 20 kg load-bearing capacity  
 (\*)

(\*)  
 Robust 1.5 mm aluminium Rack drawer  
 Continuous grip for ergonomic handling  
 Snap lock with 1.5 kg tensile strength  
 Ball bearing mounted, fully extendable telescopic rails

**Equipment protection and  
 packaging JigSaw foam unit.**  
 (Multiple combinations possible)

**Equipment protection and  
 packaging JigSaw foam unit.**  
 (Multiple combinations possible)

\* Devices not included

A3

This drawing must not be copied or disclosed without consent of the owner

Drawn by	Name	Date
projects	projects	18/07/2022
Reference	KITW01.02A2SH	
Scale	units in mm	general tolerance
1:5	DO NOT SCALE	0.8mm
1st Angle projection	FC, Wireless HR Microphone, 2CH (w/ Illum.) 2CH - Shure	



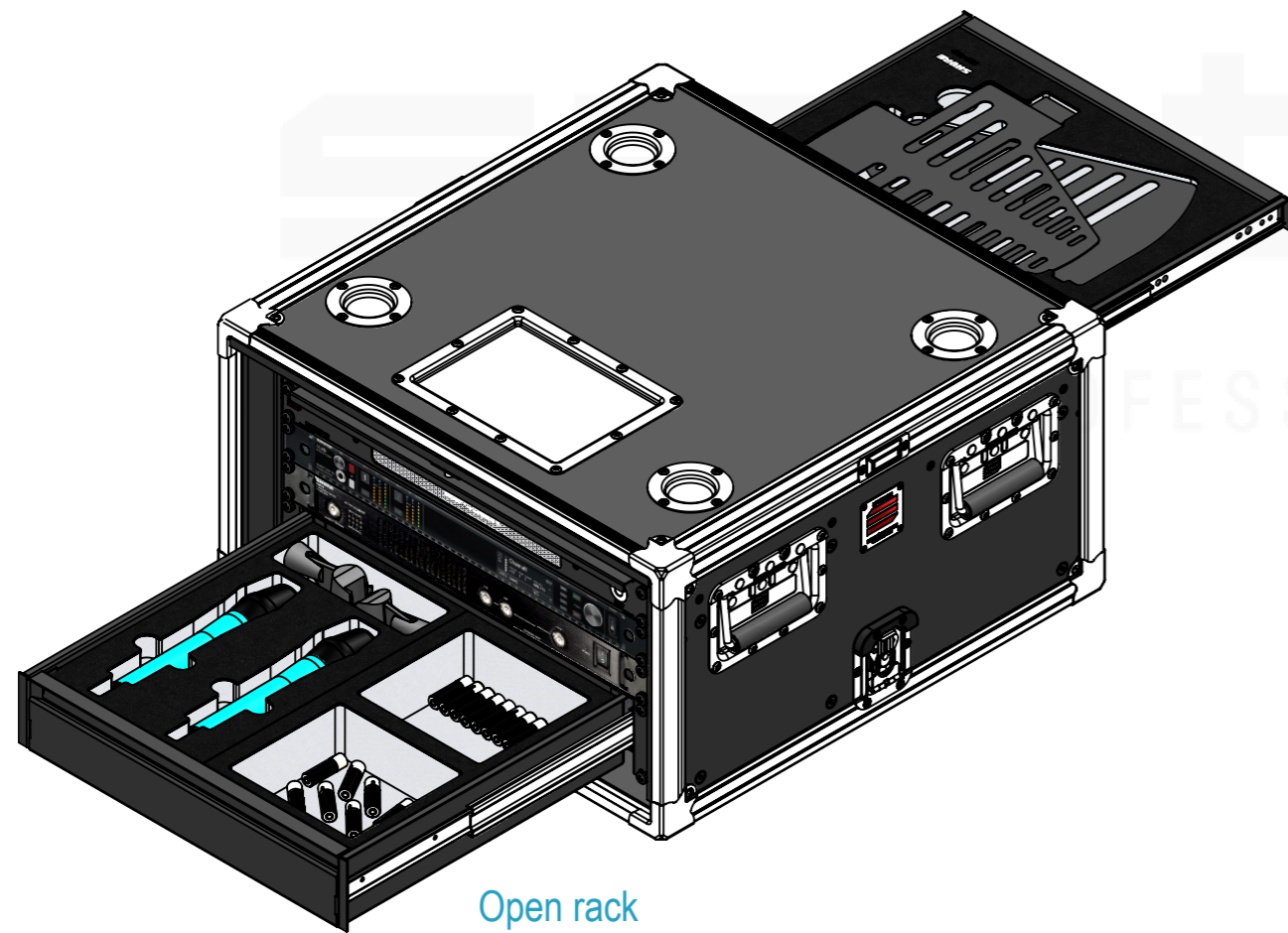
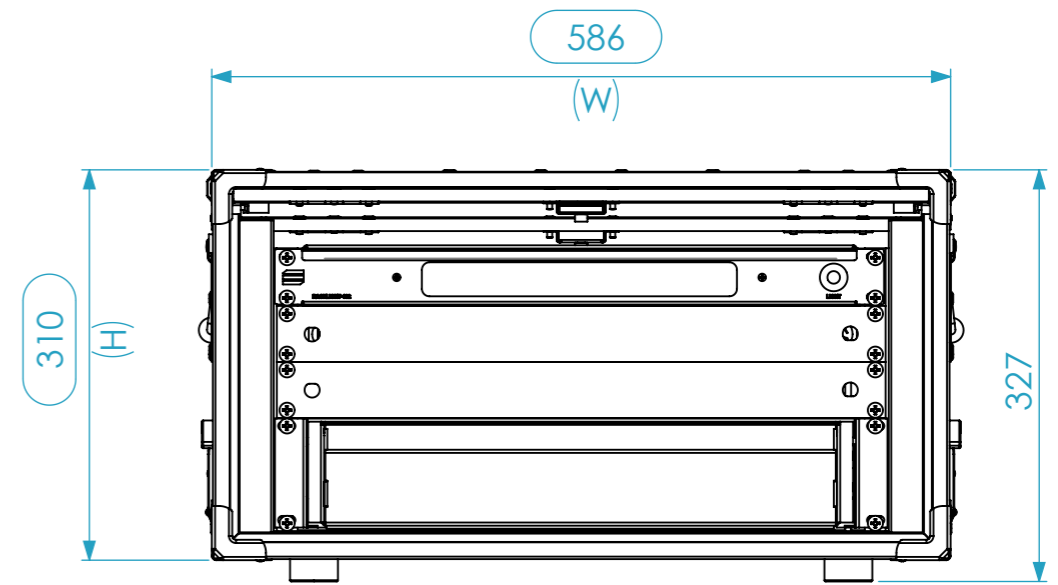
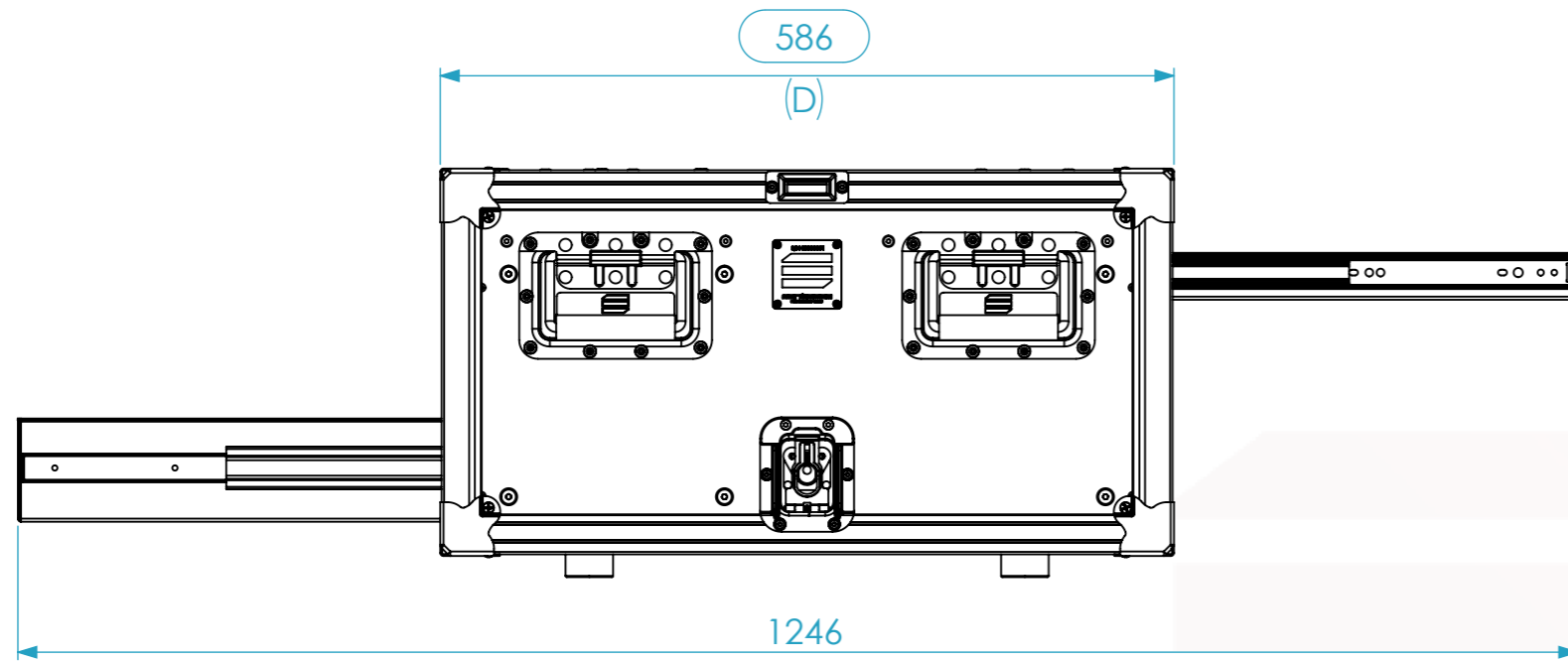

Open rack

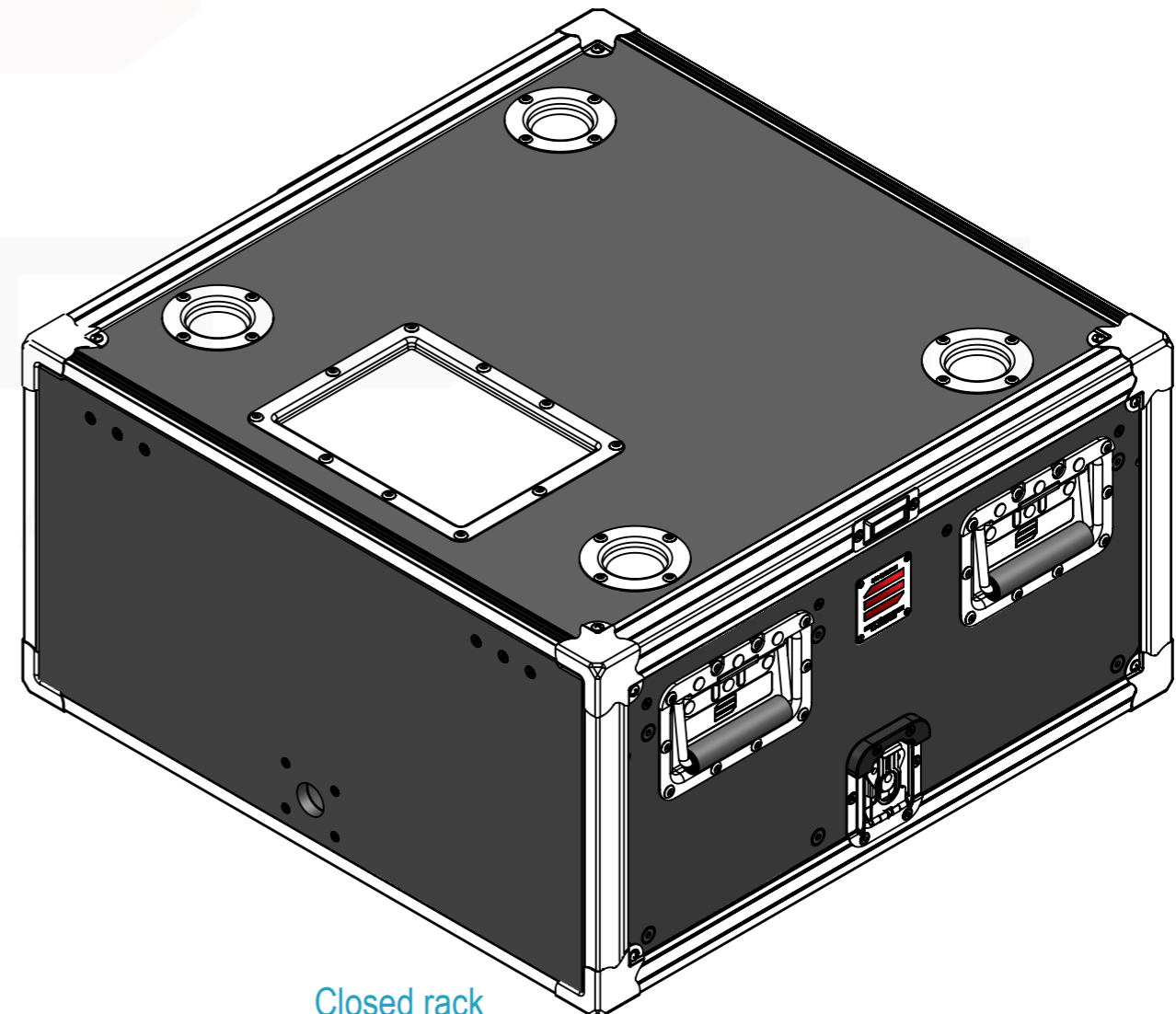

Closed rack

General External Dimensions		Usable Inner Dimensions	
W	Width	Wi	Inside Width
D	Depth	Di	Inside Depth
H	Height	Hi	Inside Height

Drawn by	projects	Name	projects	Date	18/07/2022
Reference	KITW01.02A2SH				
Scale	1:8	units in mm	DO NOT SCALE	general tolerance	0.8mm
1st Angle projection	FC, Wireless HR Microphone, 2CH (w/ illum.) 2CH - Shure				

A3 This drawing must not be copied or disclosed without consent of the owner

