

Interior dimensions		
Width	Depth	Height
1810	360	225
Weight	Approx. 14 Kg	
Wall Thickness		7mm

REVISIONS				
ZONE	REV.	DESCRIPTION	DATE	APPROVED
-	-	Final Drawing	17/09/2014	Daniel Lopes

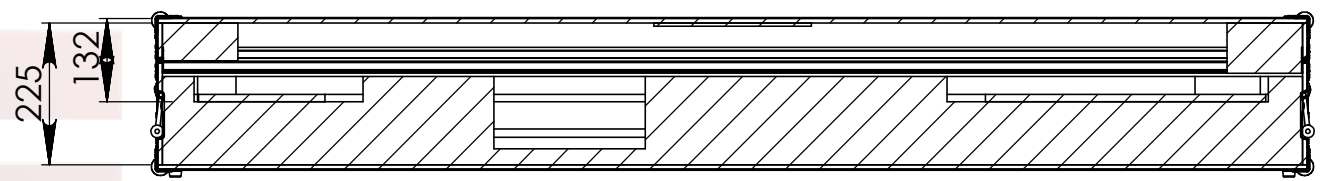

SECTION A-A

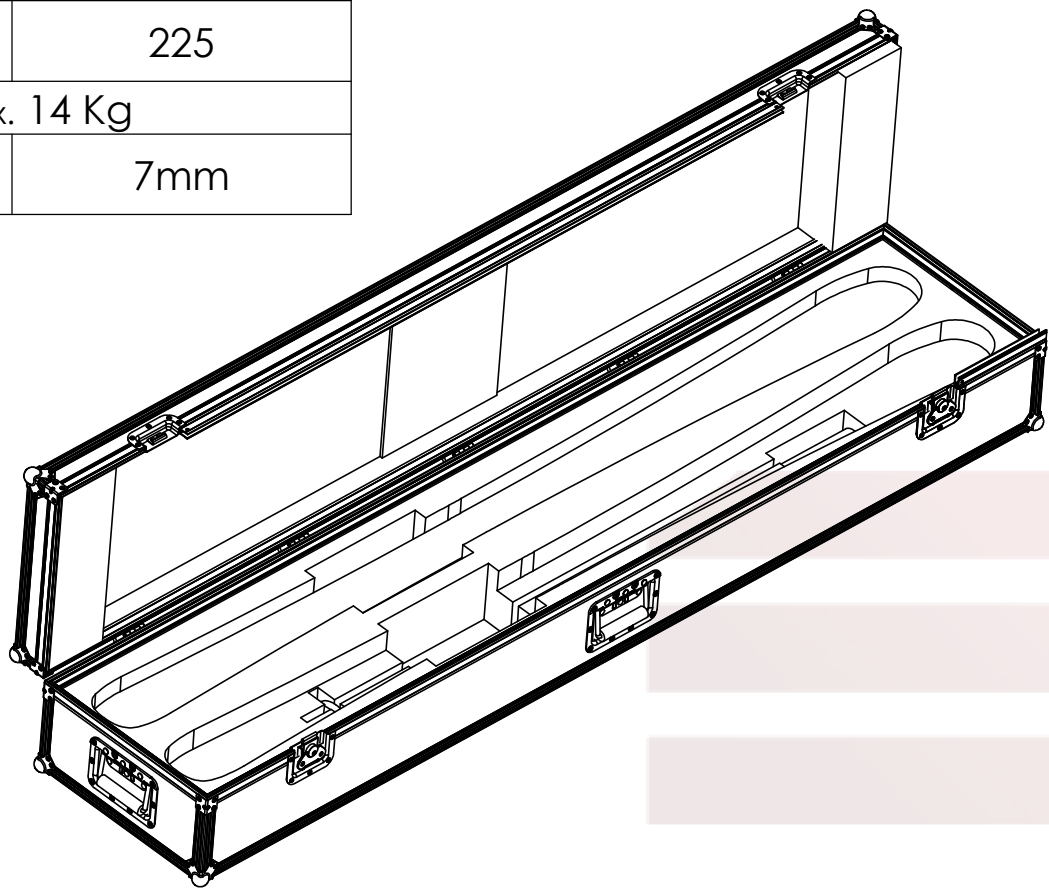
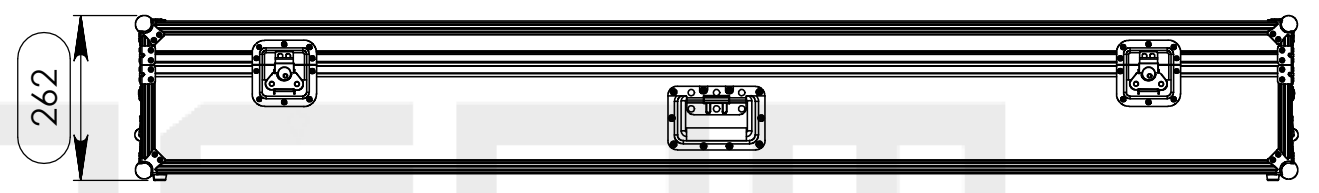
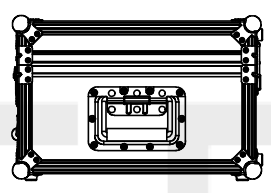
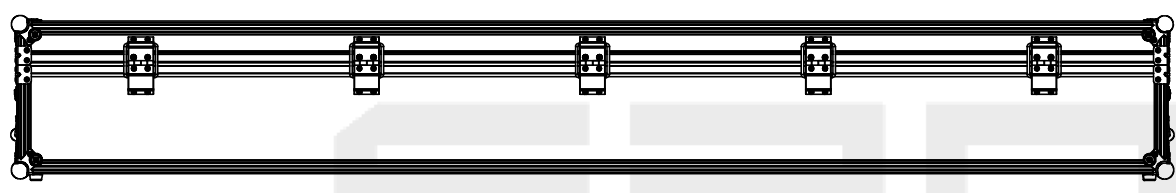

1845

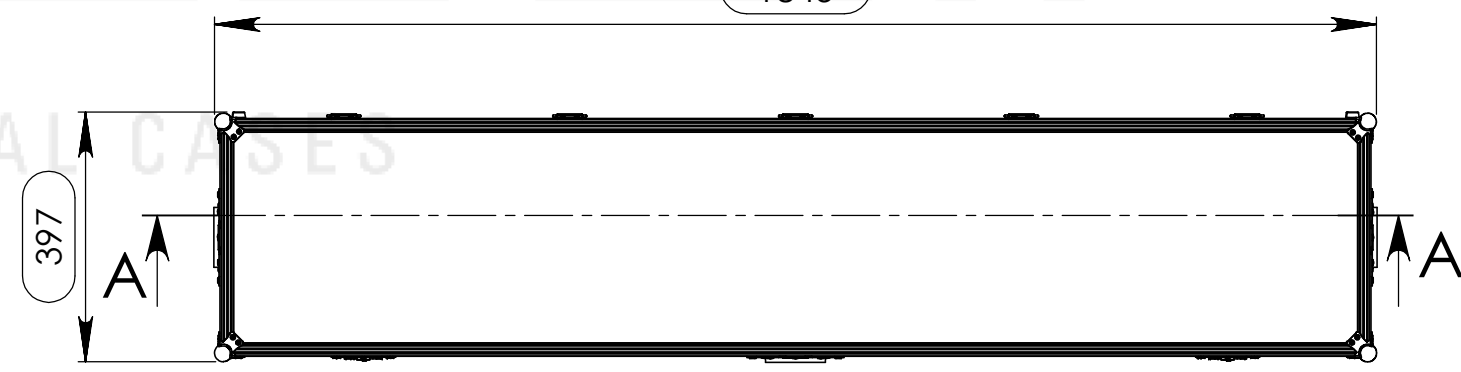
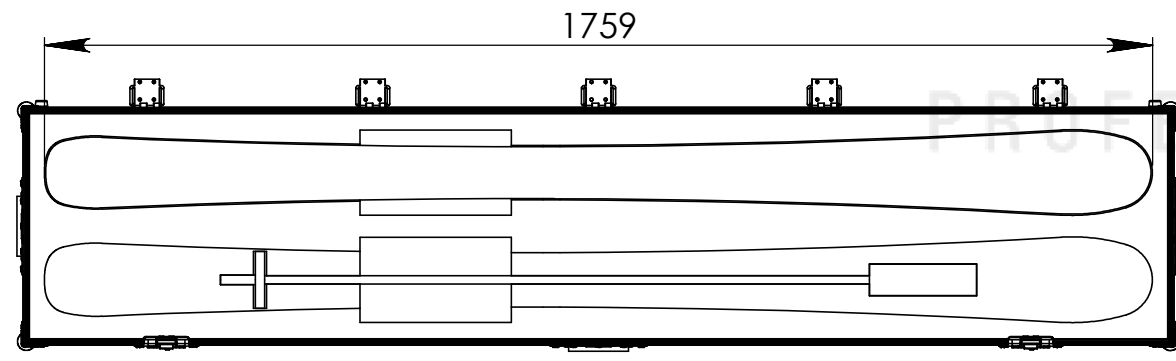

Hardware		
Qty	Ref.	Description
8	4112	Small ball corner - 3 leg - zinc plated
5	2524	Heavy Duty Strut Hinge, zinc plated
3	34082	Recessed sprung handle medium model
2	17290S	Key lockable medium Butterfly special
8	4903	Rubber foot 20 x 9 mm, black

This drawing must not be copied or disclosed without consent of the owner

Drawn by	Name	Date
DanielLopes	DanielLopes	17-09-2014
Reference	FCI.210	
Scale	units in mm	general tolerance
1:12	DO NOT SCALE	0.8mm
1st Angle projection	FC. SKI LACROX LXR	

