

Internal Dimensions		
Width	Depth	Height
756	556	1826
Weight	Approx. 85 Kg	
Wall Thickness		10mm

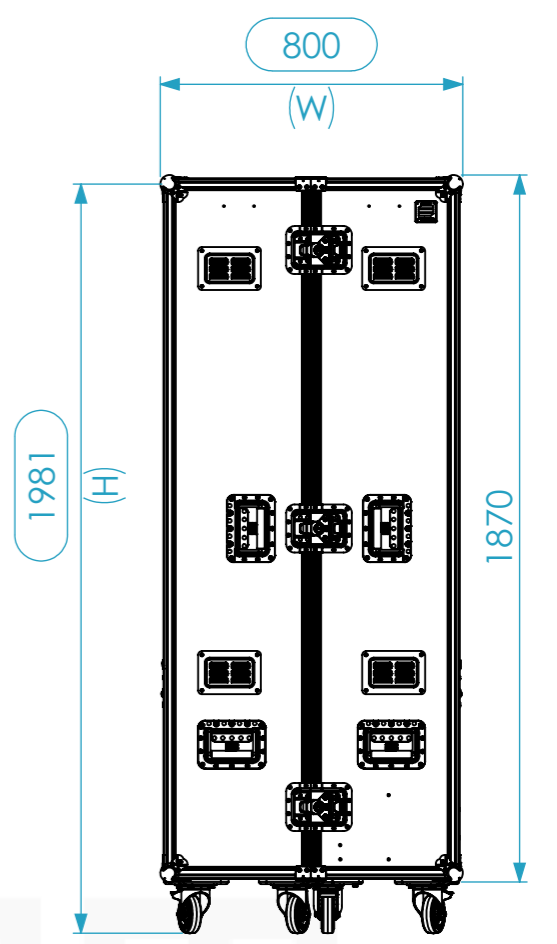

SECTION A-A

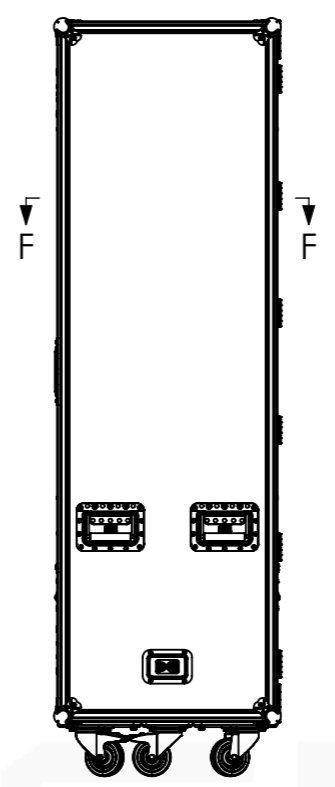
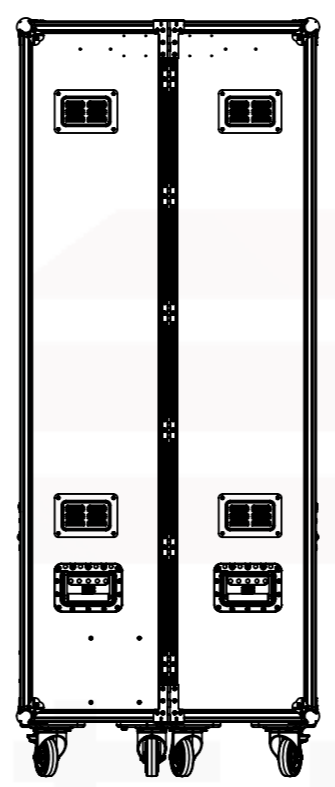
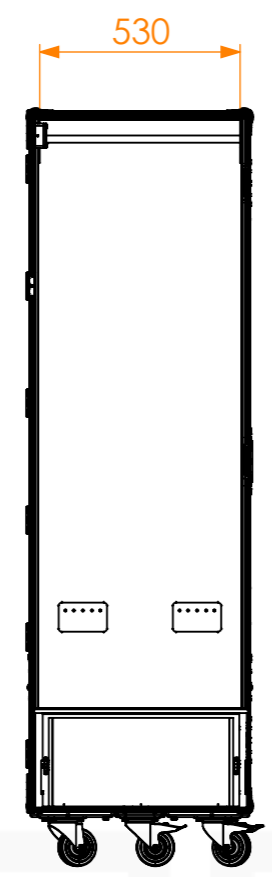
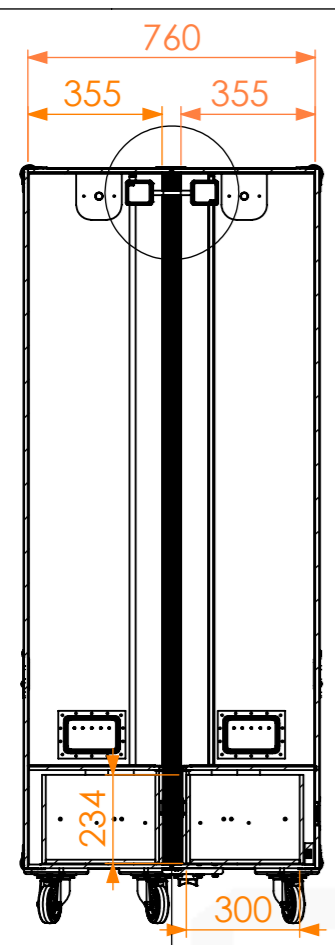
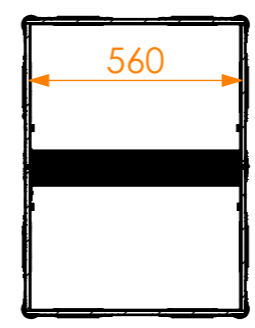
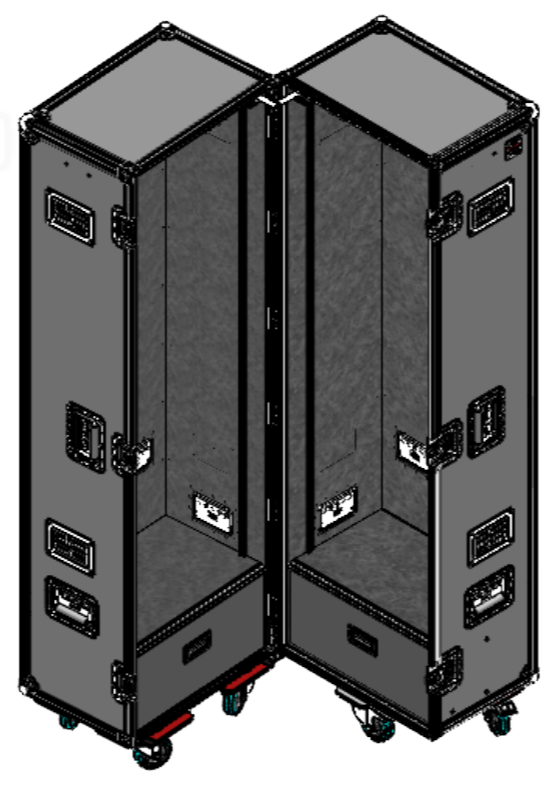
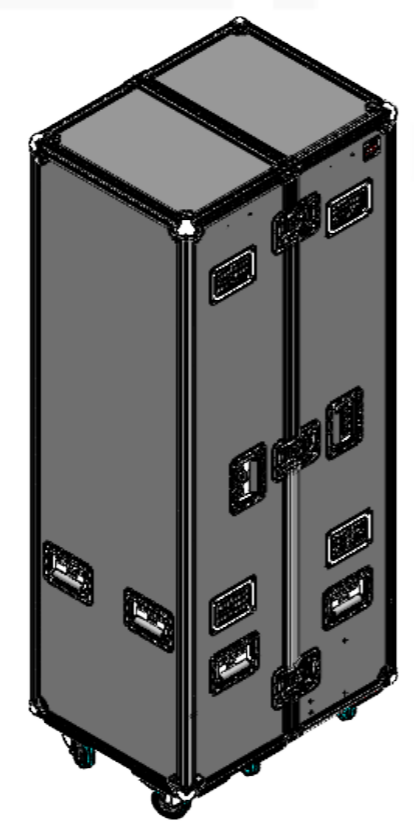
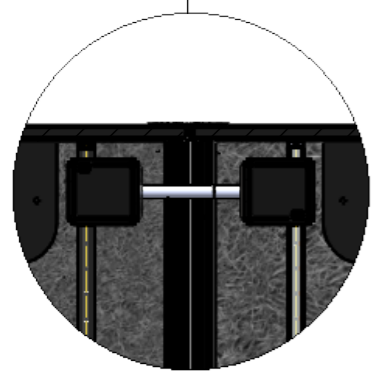

SECTION F-F

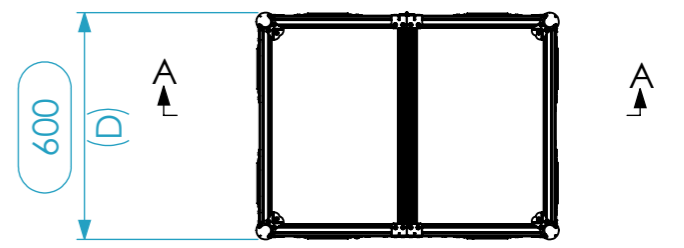

General External Dimensions	
W	Width
D	Depth
H	Height
Usable Inner Dimensions	
Wi	Inside Width
Di	Inside Depth
Hi	Inside Height

A3 This drawing must not be copied or disclosed without consent of the owner

Drawn by	Name	Date
guilherme.santos	20/05/2026	
Reference	EWD.08060187	
Scale	units in mm	general tolerance
1:20	DO NOT SCALE	0.8mm
1st Angle projection	FC, GUARDA ROUPA	



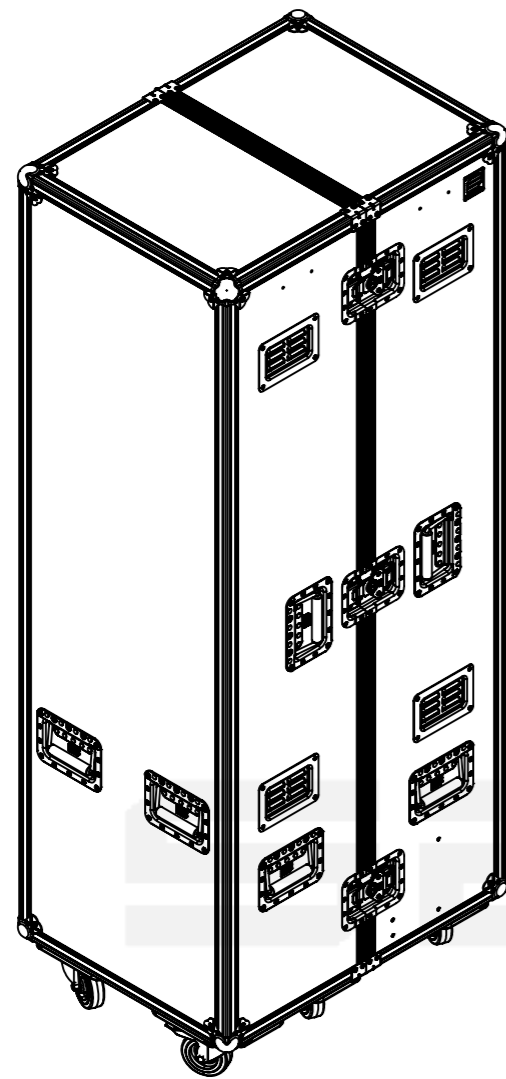

interior with carpet

Small Boxes for power routing

LED Bar

DRAWER

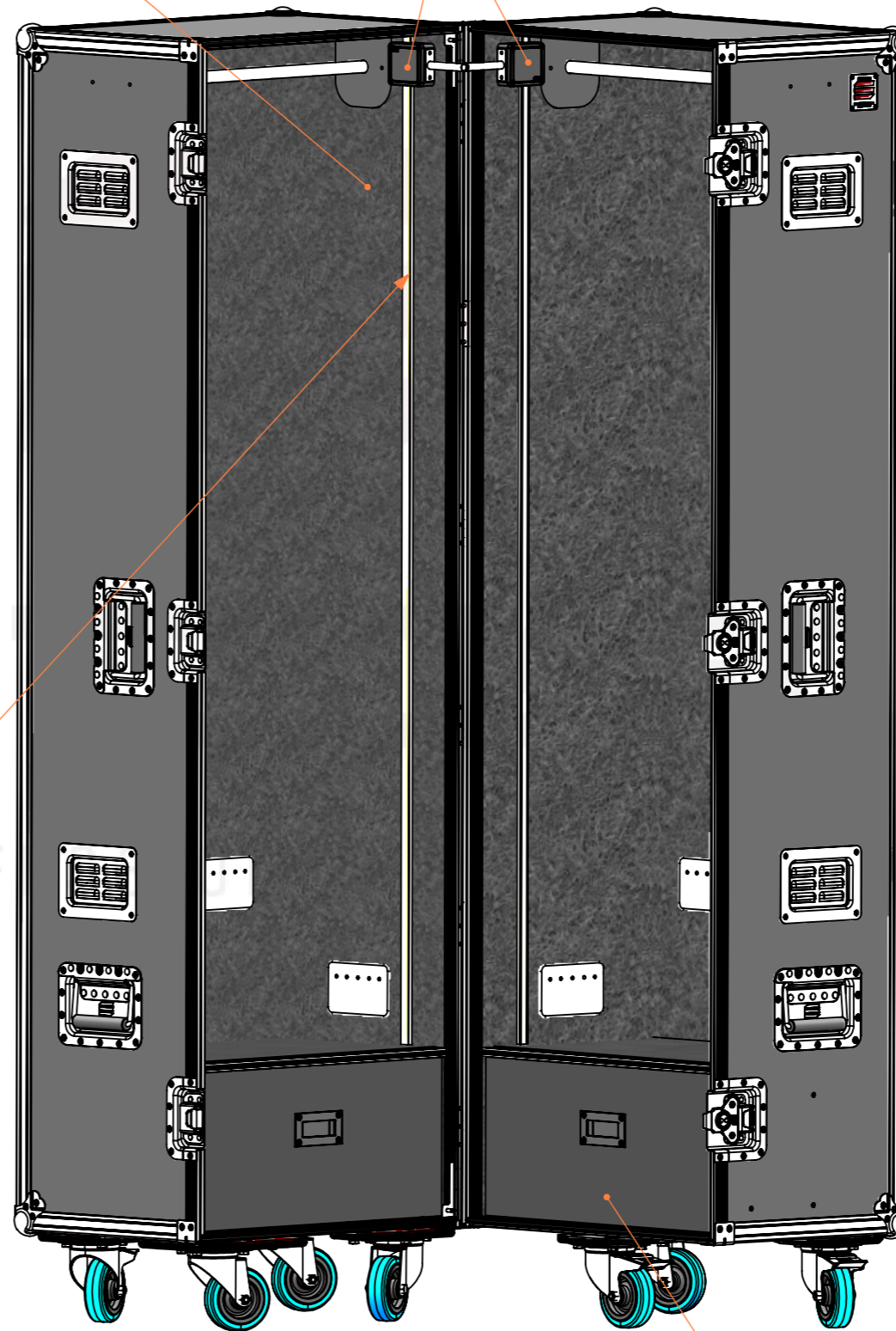

This drawing must not be copied or disclosed without consent of the owner

Drawn by	Name	Date
guilherme.santos	guilherme.santos	20/05/2026
Reference	EWD.08060187	
Scale	units in mm	general tolerance
1:15	DO NOT SCALE	0.8mm
1st Angle projection	FC, GUARDA ROUPA	



A3