

Interior dimensions		
Width	Depth	Height
2180	350	520
Weight	Approx. 32 Kg	
Wall Thickness	7mm	

REVISIONS				
ZONE	REV.	DESCRIPTION	DATE	APPROVED
-	-	Final Drawing	09/09/2014	Daniel Lopes

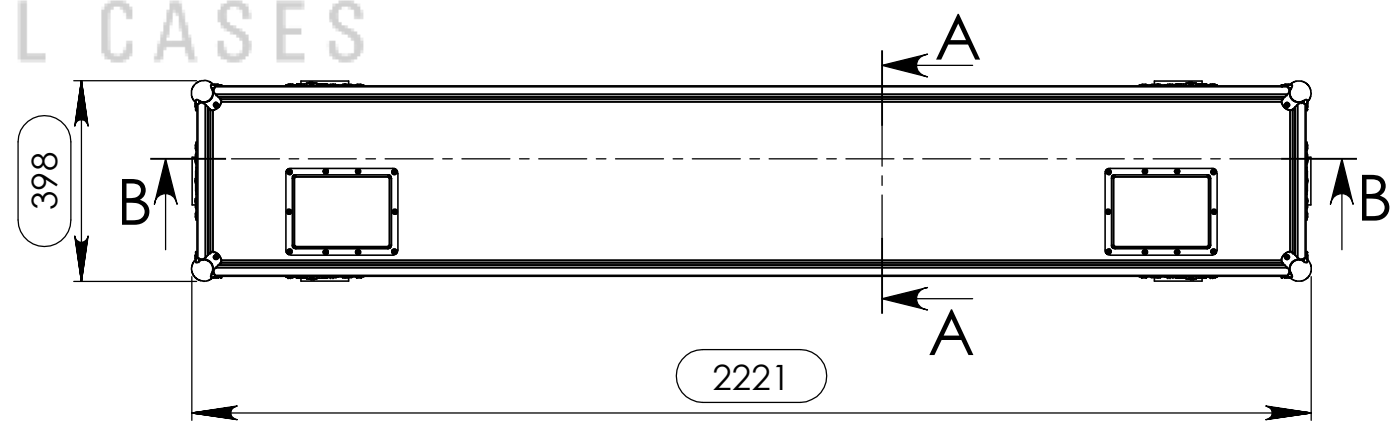
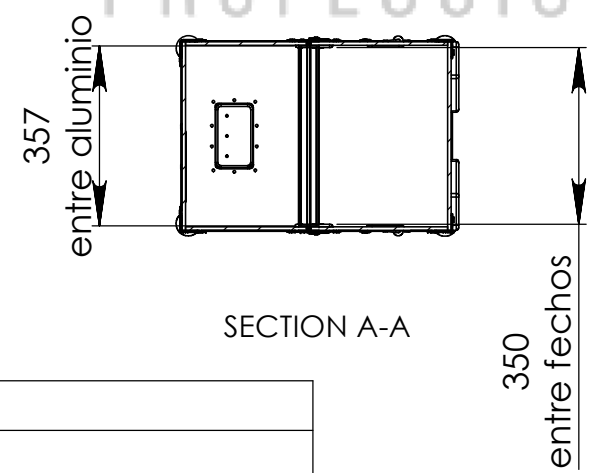
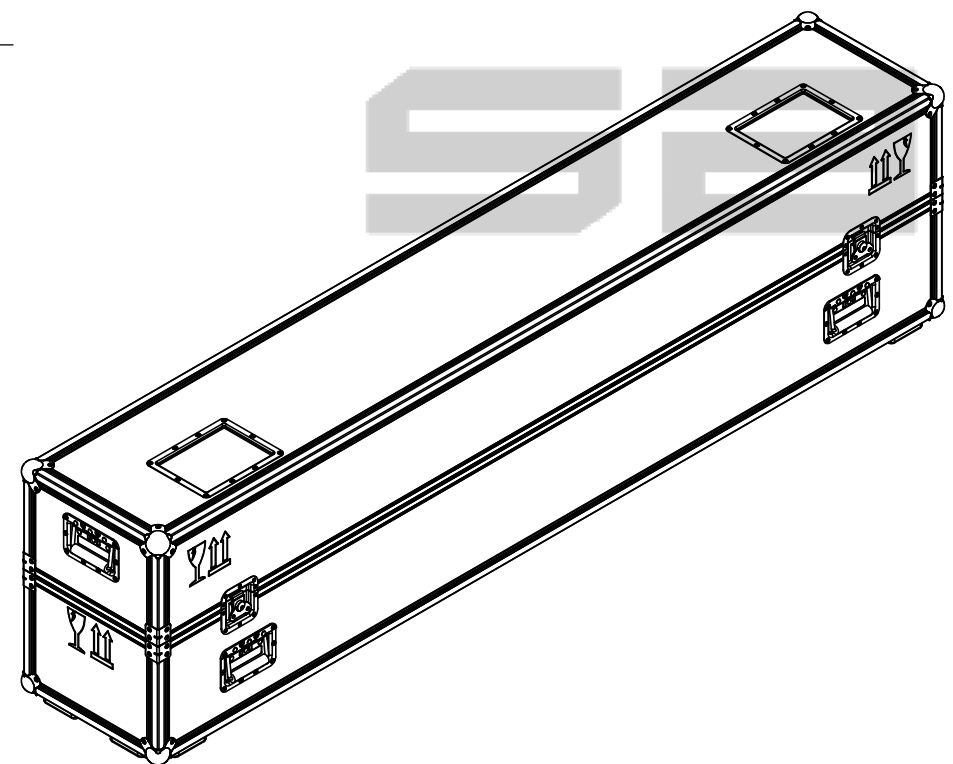
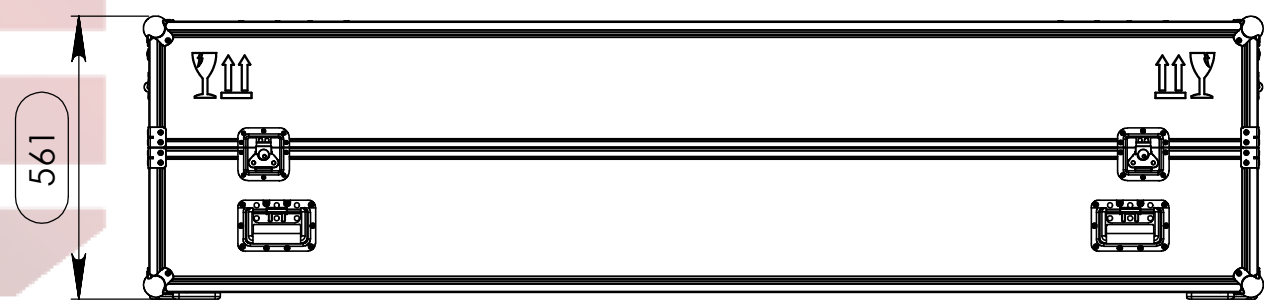
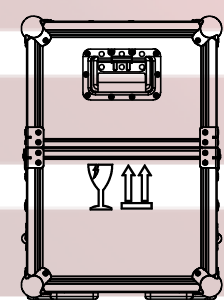
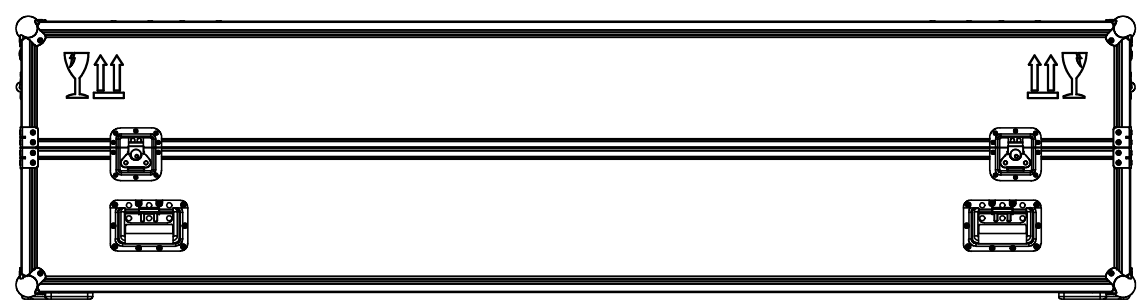
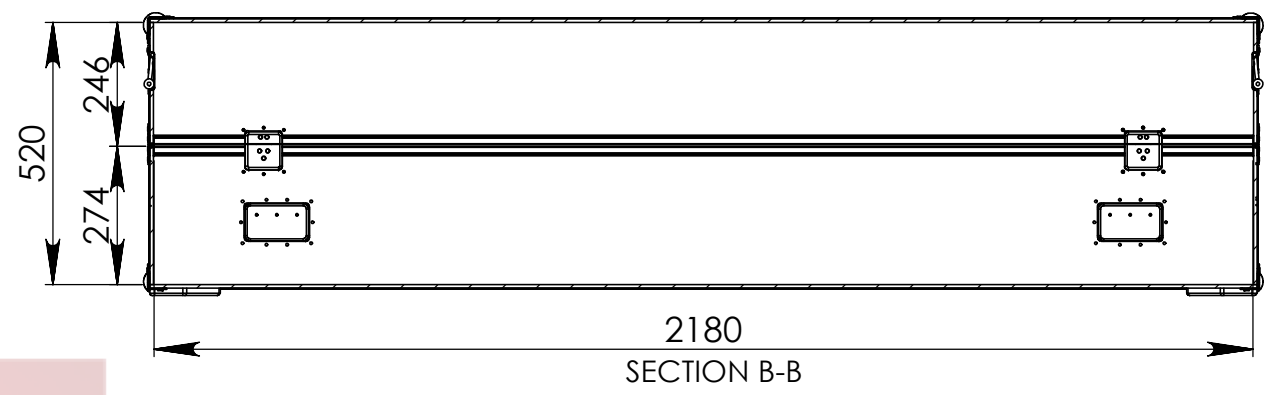

Hardware		
Qty	Ref.	Description
8	40403	Large corner bracket f. 35mm case angle
4	17290S	Key lockable medium Butterfly special
6	34082	Recessed sprung handle medium model
8	4120	Medium ball corner zinc plated
2	88001D	Dish for 88001 Tour Label

This drawing must not be copied or disclosed without consent of the owner

Drawn by	Name	Date
DanielLopes	DanielLopes	11-09-2014
Reference	816.181	
Scale	units in mm	general tolerance
1:15	DO NOT SCALE	0.8mm
1st Angle projection	FC. SUBMERCIVEL 2180X350X520	

