

Internal Dimensions		
Width	Depth	Height
706	596	810
Weight	Approx. 37 Kg	
Wall Thickness	10mm	

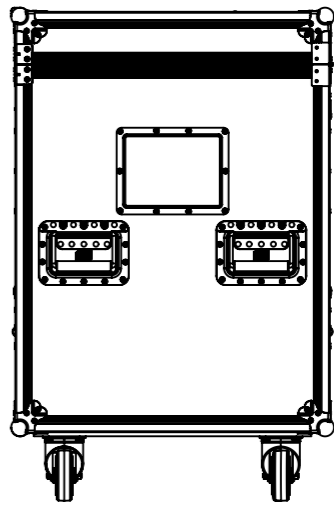
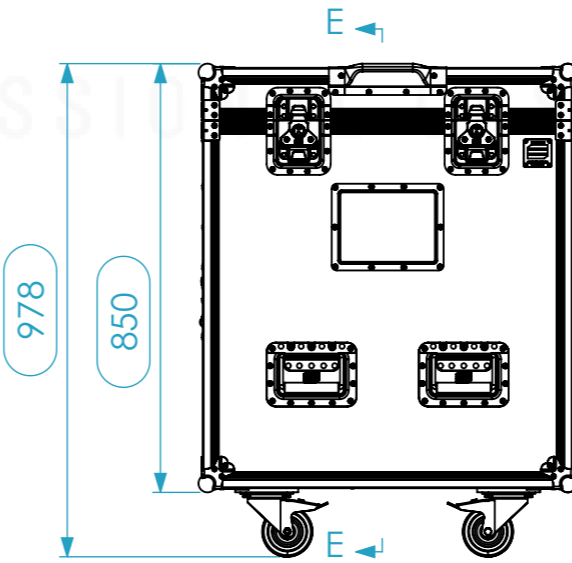
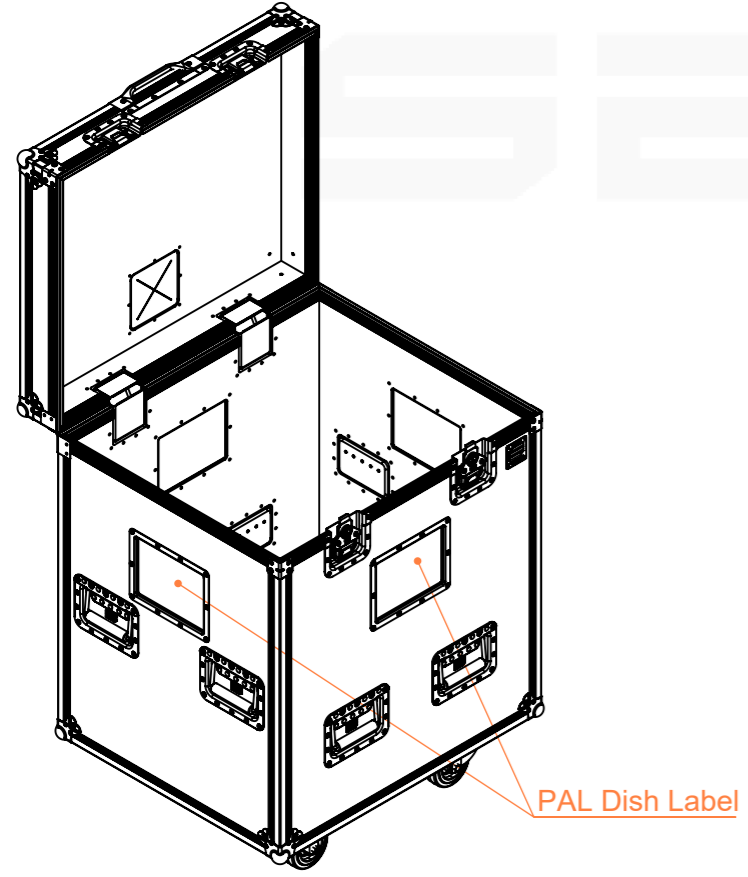
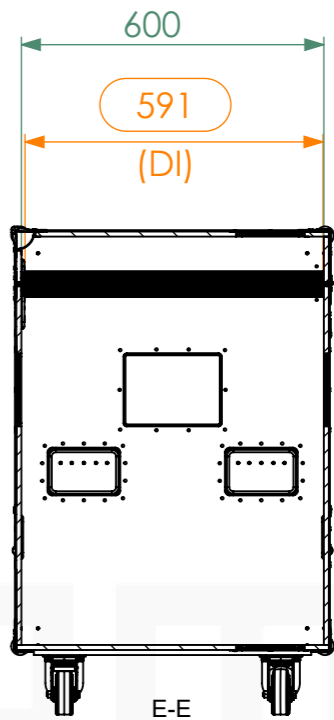
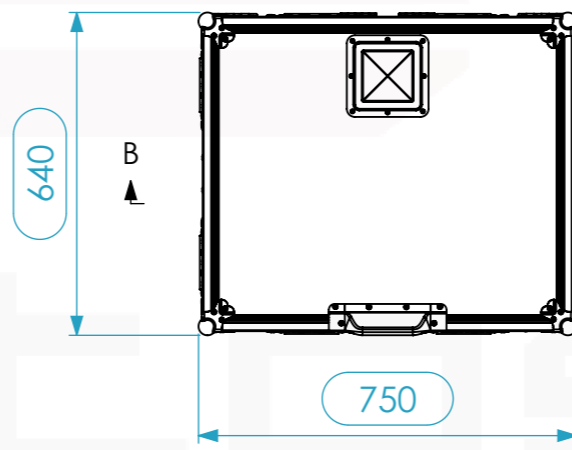
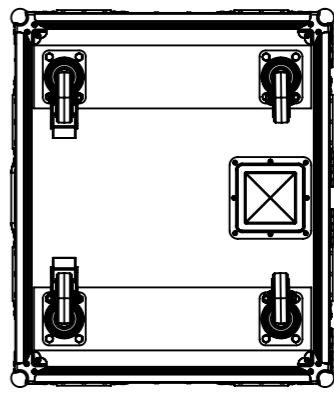
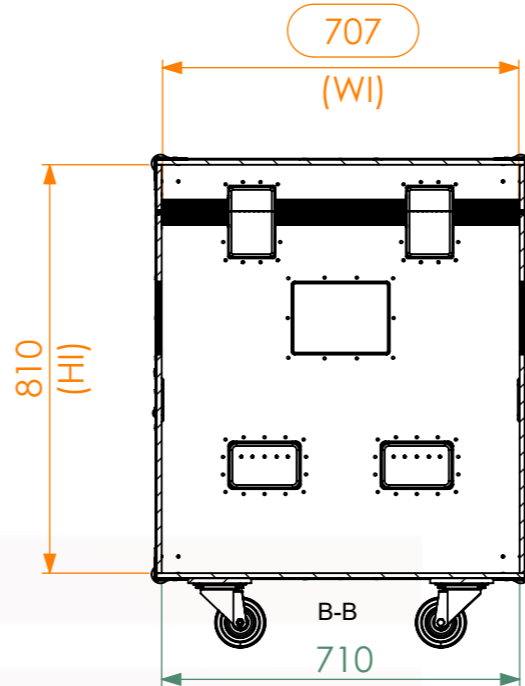
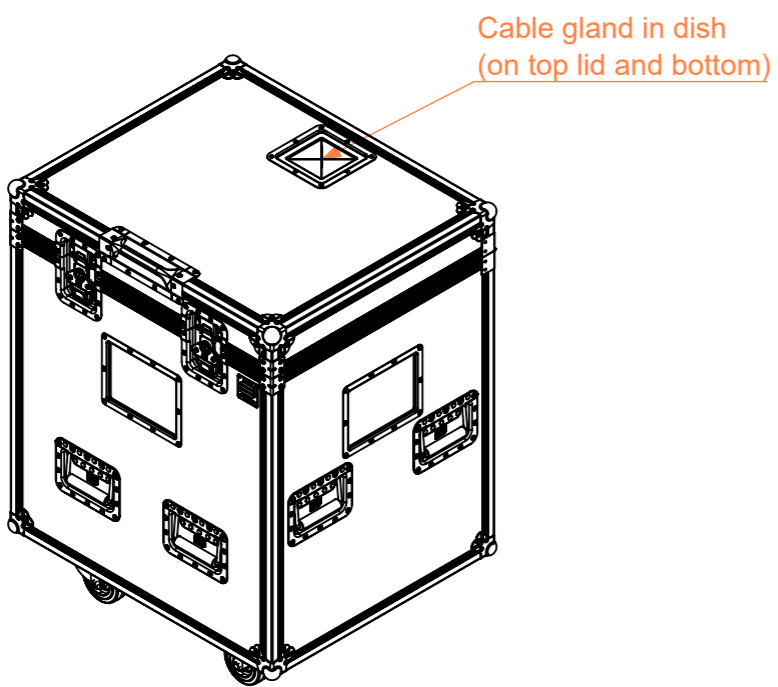

General External Dimensions		Usable Inner Dimensions		Wood Inner Dimensions	
W	Width	Wi	Inside Width	WWi	Wood Inside Width
D	Depth	Di	Inside Depth	WDi	Wood Inside Depth
H	Height	Hi	Inside Height	WHi	Wood Inside Height

This drawing must not be copied or disclosed without consent of the owner

Drawn by	Name	Date
CarlaSilva	CarlaSilva	28/08/2019
Reference	3301.002	
Scale	units in mm	general tolerance
1:15	DO NOT SCALE	0.8mm
Flight case PRO X2 Elation Demo Equipment		

